

FEATURES

- **Low Quiescent Current:**
 20 μ A in Active Mode
 <1 μ A in Shutdown Mode
- **Operates with V_{IN} as Low as 1V**
- Low V_{CESAT} Switch: 250mV at 300mA
- Uses Small Surface Mount Components
- High Output Voltage: Up to 34V
- Low Profile (1mm) ThinSOT™ Package

APPLICATIONS

- LCD Bias
- Handheld Computers
- Battery Backup
- Digital Cameras

DESCRIPTION

The LT®1615/LT1615-1 are micropower step-up DC/DC converters in a 5-lead low profile (1mm) ThinSOT package. The LT1615 is designed for higher power systems with a 350mA current limit and an input voltage range of 1.2V to 15V, whereas the LT1615-1 is intended for lower power and single-cell applications with a 100mA current limit and an extended input voltage range of 1V to 15V. Otherwise, the two devices are functionally equivalent. Both devices feature a quiescent current of only 20 μ A at no load, which further reduces to 0.5 μ A in shutdown. A current limited, fixed off-time control scheme conserves operating current, resulting in high efficiency over a broad range of load current. The 36V switch allows high voltage outputs up to 34V to be easily generated in a simple boost topology without the use of costly transformers. The LT1615's low off-time of 400ns permits the use of tiny, low profile inductors and capacitors to minimize footprint and cost in space-conscious portable applications.

LT, LTC and LT are registered trademarks of Linear Technology Corporation. ThinSOT is a trademark of Linear Technology Corporation.

TYPICAL APPLICATION

1-Cell Li-Ion to 20V Converter for LCD Bias

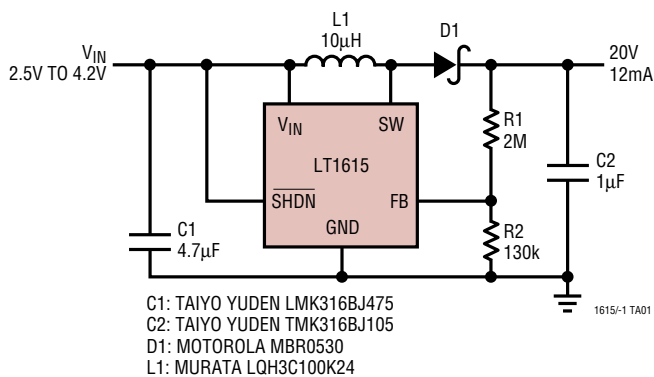

Efficiency

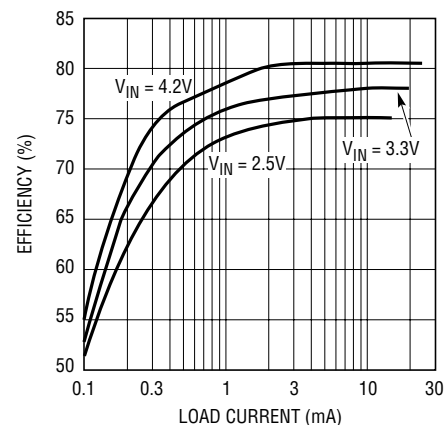

ABSOLUTE MAXIMUM RATINGS

(Note 1)

V_{IN} , \overline{SHDN} Voltage	15V
SW Voltage	36V
FB Voltage	V_{IN}
Current into FB Pin	1mA
Junction Temperature	125°C
Operating Temperature Range (Note 2) ..	-40°C to 85°C
Storage Temperature Range	-65°C to 150°C
Lead Temperature (Soldering, 10 sec)	300°C

PACKAGE/ORDER INFORMATION

<p>TOP VIEW</p> <p>SW 1 5 V_{IN}</p> <p>GND 2</p> <p>FB 3 4 \overline{SHDN}</p> <p>S5 PACKAGE 5-LEAD PLASTIC SOT-23</p> <p>$T_{JMAX} = 125^{\circ}C, \theta_{JA} = 256^{\circ}C/W$</p>	ORDER PART NUMBER
	LT1615ES5 LT1615ES5-1 LT1615IS5 LT1615IS5-1
	S5 PART MARKING
	LTIZ LTKH LTXZ LTBHT

Consult LTC Marketing for parts specified with wider operating temperature ranges.

ELECTRICAL CHARACTERISTICS

The ● denotes the specifications which apply over the full operating temperature range, otherwise specifications are at $T_A = 25^{\circ}C$. $V_{IN} = 1.2V$, $V_{\overline{SHDN}} = 1.2V$ unless otherwise noted.

PARAMETER	CONDITIONS	MIN	TYP	MAX	UNITS
Minimum Input Voltage	LT1615-1			1.0	V
	LT1615			1.2	V
Quiescent Current	Not Switching $V_{\overline{SHDN}} = 0V$		20	30	μA
				1	μA
FB Comparator Trip Point		● 1.205	1.23	1.255	V
FB Comparator Hysteresis			8		mV
Output Voltage Line Regulation	$1.2V < V_{IN} < 12V$		0.05	0.1	%/V
FB Pin Bias Current (Note 3)	$V_{FB} = 1.23V$	●	30	80	nA
Switch Off Time	$V_{FB} > 1V$ $V_{FB} < 0.6V$		400		ns
			1.5		μs
Switch V_{CESAT}	$I_{SW} = 70mA$ (LT1615-1) $I_{SW} = 300mA$ (LT1615)		85	120	mV
			250	350	mV
Switch Current Limit	LT1615-1 LT1615	75	100	125	mA
		300	350	400	mA
\overline{SHDN} Pin Current	$V_{\overline{SHDN}} = 1.2V$ $V_{\overline{SHDN}} = 5V$		2	3	μA
			8	12	μA
\overline{SHDN} Input Voltage High		0.9			V
\overline{SHDN} Input Voltage Low				0.25	V
Switch Leakage Current	Switch Off, $V_{SW} = 5V$		0.01	5	μA

Note 1: Absolute Maximum Ratings are those values beyond which the life of a device may be impaired.

Note 2: The LT1615E and LT1615E-1 are guaranteed to meet performance specifications from 0°C to 70°C. Specifications over the -40°C to 85°C operating temperature range are assured by design,

characterization and correlation with statistical process controls. The LT1615I/LT1615I-1 is guaranteed to meet performance specifications over the -40°C to 85°C operating temperature range.

Note 3: Bias current flows into the FB pin.

TYPICAL PERFORMANCE CHARACTERISTICS

Switch Saturation Voltage (V_{CESAT})

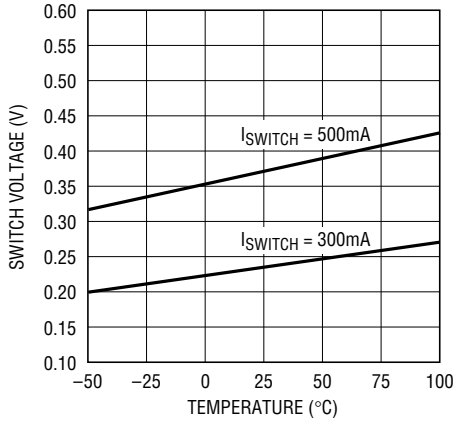

1615-1 G01

Feedback Pin Voltage and Bias Current

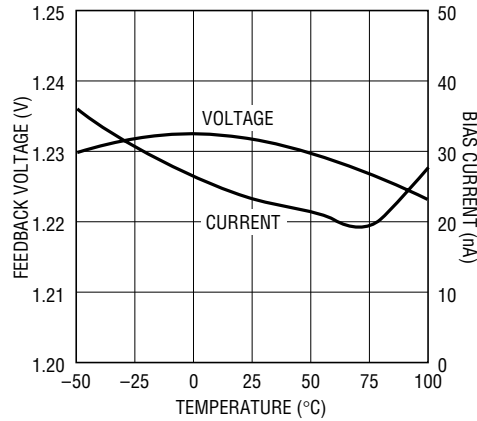

1615-1 G02

Quiescent Current

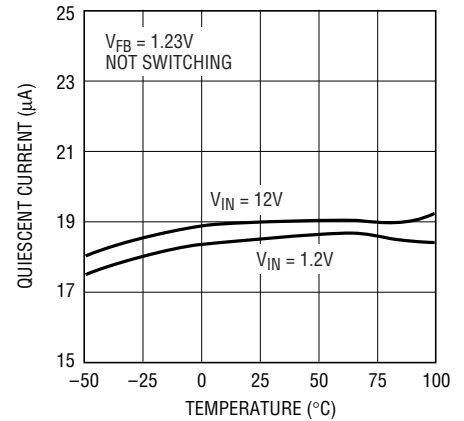

1615-1 G03

Switch Off Time

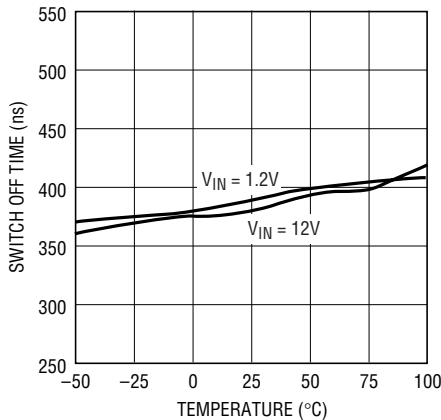

1615-1 G04

Switch Current Limit

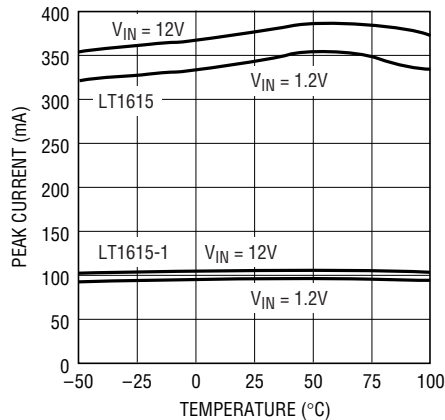

1615-1 G05

Shutdown Pin Current

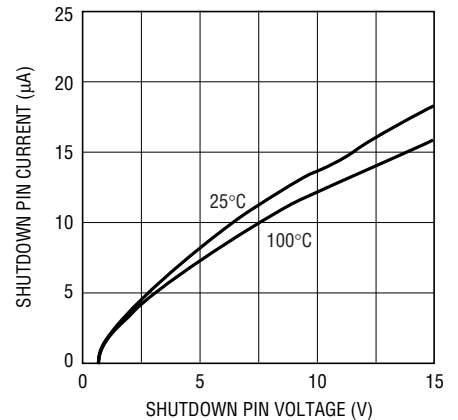

1615-1 G03

PIN FUNCTIONS

SW (Pin 1): Switch Pin. This is the collector of the internal NPN power switch. Minimize the metal trace area connected to this pin to minimize EMI.

GND (Pin 2): Ground. Tie this pin directly to the local ground plane.

FB (Pin 3): Feedback Pin. Set the output voltage by selecting values for R1 and R2 (see Figure 1):

$$R1 = R2 \left(\frac{V_{OUT}}{1.23} - 1 \right)$$

SHDN (Pin 4): Shutdown Pin. Tie this pin to 0.9V or higher to enable the device. Tie below 0.25V to turn off the device.

V_{IN} (Pin 5): Input Supply Pin. Bypass this pin with a capacitor as close to the device as possible.

BLOCK DIAGRAM

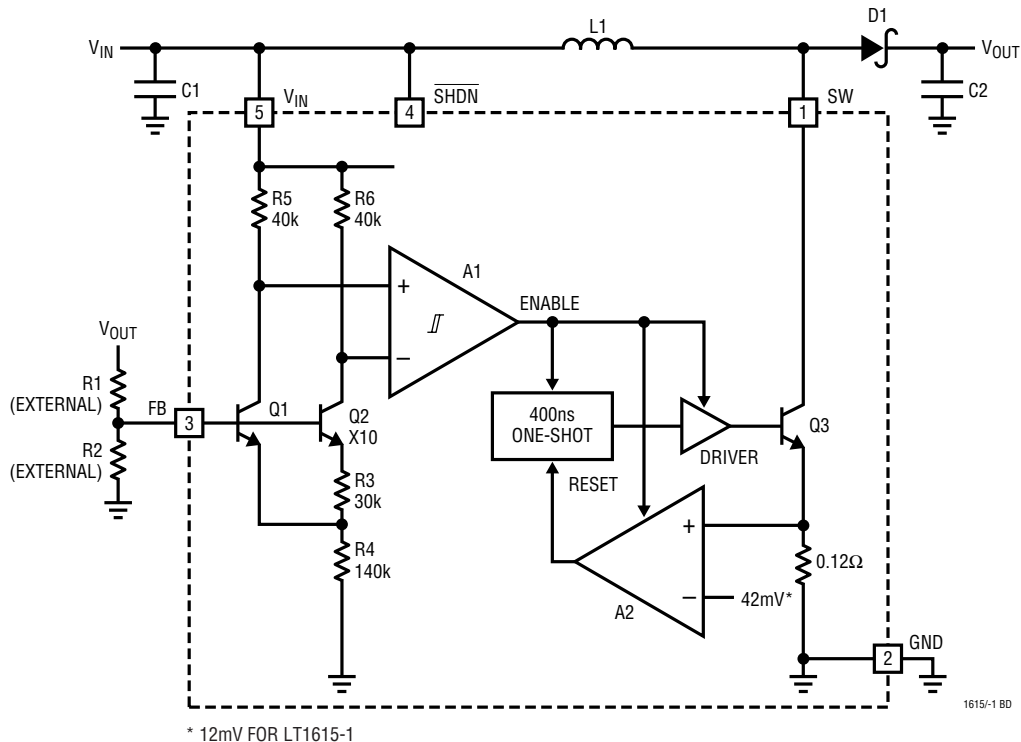

Figure 1. LT1615 Block Diagram

OPERATION

The LT1615 uses a constant off-time control scheme to provide high efficiencies over a wide range of output current. Operation can be best understood by referring to the block diagram in Figure 1. Q1 and Q2 along with R3 and R4 form a bandgap reference used to regulate the output voltage. When the voltage at the FB pin is slightly above 1.23V, comparator A1 disables most of the internal circuitry. Output current is then provided by capacitor C2, which slowly discharges until the voltage at the FB pin drops below the lower hysteresis point of A1 (typical hysteresis at the FB pin is 8mV). A1 then enables the internal circuitry, turns on power switch Q3, and the current in inductor L1 begins ramping up. Once the switch current reaches 350mA, comparator A2 resets the one-shot, which turns off Q3 for 400ns. L1 then delivers current to the output through diode D1 as the inductor current ramps down. Q3 turns on again and the inductor

current ramps back up to 350mA, then A2 resets the one-shot, again allowing L1 to deliver current to the output. This switching action continues until the output voltage is charged up (until the FB pin reaches 1.23V), then A1 turns off the internal circuitry and the cycle repeats. The LT1615 contains additional circuitry to provide protection during start-up and under short-circuit conditions. When the FB pin voltage is less than approximately 600mV, the switch off-time is increased to 1.5μs and the current limit is reduced to around 250mA (70% of its normal value). This reduces the average inductor current and helps minimize the power dissipation in the LT1615 power switch and in the external inductor and diode. The LT1615-1 operates in the same manner, except the switch current is limited to 100mA (the A2 reference voltage is 12mV instead of 42mV).

APPLICATIONS INFORMATION

Choosing an Inductor

Several recommended inductors that work well with the LT1615 and LT1615-1 are listed in Table 1, although there are many other manufacturers and devices that can be used. Consult each manufacturer for more detailed information and for their entire selection of related parts. Many different sizes and shapes are available. Use the equations and recommendations in the next few sections to find the correct inductance value for your design.

Table 1. Recommended Inductors

PART	VALUE (μH)	MAX DCR (Ω)	VENDOR
LQH3C4R7	4.7	0.26	Murata (814) 237-1431 www.murata.com
LQH3C100	10	0.30	
LQH3C220	22	0.92	
CD43-4R7	4.7	0.11	Sumida (847) 956-0666 www.sumida.com
CD43-100	10	0.18	
CDRH4D18-4R7	4.7	0.16	
CDRH4D18-100	10	0.20	
DO1608-472	4.7	0.09	Coilcraft (847) 639-6400 www.coilcraft.com
DO1608-103	10	0.16	
DO1608-223	22	0.37	

Inductor Selection—Boost Regulator

The formula below calculates the appropriate inductor value to be used for a boost regulator using the LT1615 or LT1615-1 (or at least provides a good starting point). This value provides a good tradeoff in inductor size and system performance. Pick a standard inductor close to this value. A larger value can be used to slightly increase the available output current, but limit it to around twice the value calculated below, as too large of an inductance will increase the output voltage ripple without providing much additional output current. A smaller value can be used (especially for systems with output voltages greater than 12V) to give a smaller physical size. Inductance can be calculated as:

$$L = \frac{V_{OUT} - V_{IN(MIN)} + V_D}{I_{LIM}} t_{OFF}$$

where $V_D = 0.4V$ (Schottky diode voltage), $I_{LIM} = 350mA$ or $100mA$, and $t_{OFF} = 400ns$; for designs with varying V_{IN} such as battery powered applications, use the minimum

V_{IN} value in the above equation. For most systems with output voltages below 7V, a $4.7\mu H$ inductor is the best choice, even though the equation above might specify a smaller value. This is due to the inductor current overshoot that occurs when very small inductor values are used (see Current Limit Overshoot section).

For higher output voltages, the formula above will give large inductance values. For a 2V to 20V converter (typical LCD Bias application), a $21\mu H$ inductor is called for with the above equation, but a $10\mu H$ inductor could be used without excessive reduction in maximum output current.

Inductor Selection—SEPIC Regulator

The formula below calculates the approximate inductor value to be used for a SEPIC regulator using the LT1615. As for the boost inductor selection, a larger or smaller value can be used.

$$L = 2 \left(\frac{V_{OUT} + V_D}{I_{LIM}} \right) t_{OFF}$$

Current Limit Overshoot

For the constant off-time control scheme of the LT1615, the power switch is turned off only after the 350mA (or 100mA) current limit is reached. There is a 100ns delay between the time when the current limit is reached and when the switch actually turns off. During this delay, the inductor current exceeds the current limit by a small amount. The peak inductor current can be calculated by:

$$I_{PEAK} = I_{LIM} + \left(\frac{V_{IN(MAX)} - V_{SAT}}{L} \right) 100ns$$

Where $V_{SAT} = 0.25V$ (switch saturation voltage). The current overshoot will be most evident for systems with high input voltages and for systems where smaller inductor values are used. This overshoot can be beneficial as it helps increase the amount of available output current for smaller inductor values. This will be the peak current seen by the inductor (and the diode) during normal operation. For designs using small inductance values (especially at

APPLICATIONS INFORMATION

input voltages greater than 5V), the current limit overshoot can be quite high. Although it is internally current limited to 350mA, the power switch of the LT1615 can handle larger currents without problem, but the overall efficiency will suffer. Best results will be obtained when I_{PEAK} is kept below 700mA for the LT1615 and below 400mA for the LT1615-1.

Capacitor Selection

Low ESR (Equivalent Series Resistance) capacitors should be used at the output to minimize the output ripple voltage. Multilayer ceramic capacitors are the best choice, as they have a very low ESR and are available in very small packages. Their small size makes them a good companion to the LT1615's SOT-23 package. Solid tantalum capacitors (like the AVX TPS, Sprague 593D families) or OS-CON capacitors can be used, but they will occupy more board area than a ceramic and will have a higher ESR. Always use a capacitor with a sufficient voltage rating.

Ceramic capacitors also make a good choice for the input decoupling capacitor, which should be placed as close as possible to the LT1615. A 4.7 μ F input capacitor is sufficient for most applications. Table 2 shows a list of several capacitor manufacturers. Consult the manufacturers for more detailed information and for their entire selection of related parts.

Diode Selection

For most LT1615 applications, the Motorola MBR0520 surface mount Schottky diode (0.5A, 20V) is an ideal choice. Schottky diodes, with their low forward voltage drop and fast switching speed, are the best match for the LT1615. For higher output voltage applications the 30V MBR0530 can be used. Many different manufacturers make equivalent parts, but make sure that the component is rated to handle at least 0.35A. For LT1615-1 applications, a Philips BAT54 or Central Semiconductor CMDSH-3 works well.

Lowering Output Voltage Ripple

Using low ESR capacitors will help minimize the output ripple voltage, but proper selection of the inductor and the output capacitor also plays a big role. The LT1615 provides energy to the load in bursts by ramping up the inductor current, then delivering that current to the load. If too large of an inductor value or too small of a capacitor value is used, the output ripple voltage will increase because the capacitor will be slightly overcharged each burst cycle. To reduce the output ripple, increase the output capacitor value or add a 4.7pF feed-forward capacitor in the feedback network of the LT1615 (see the circuits in the Typical Applications section). Adding this small, inexpensive 4.7pF capacitor will greatly reduce the output voltage ripple.

Table 2. Recommended Capacitors

CAPACITOR TYPE	VENDOR
Ceramic	Taiyo Yuden (408) 573-4150 www.t-yuden.com
Ceramic	AVX (803) 448-9411 www.avxcorp.com
Ceramic	Murata (714) 852-2001 www.murata.com

TYPICAL APPLICATIONS

2-Cell to 3.3V Boost Converter

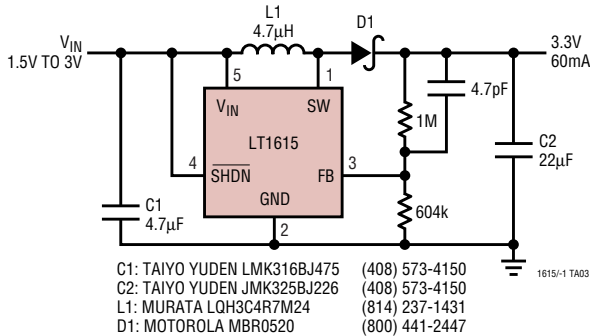

2-Cell to 3.3V Converter Efficiency

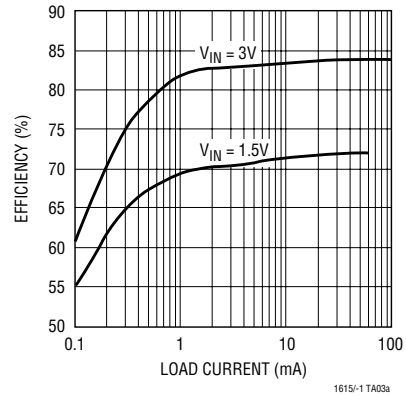

1-Cell Li-Ion to 3.3V SEPIC Converter

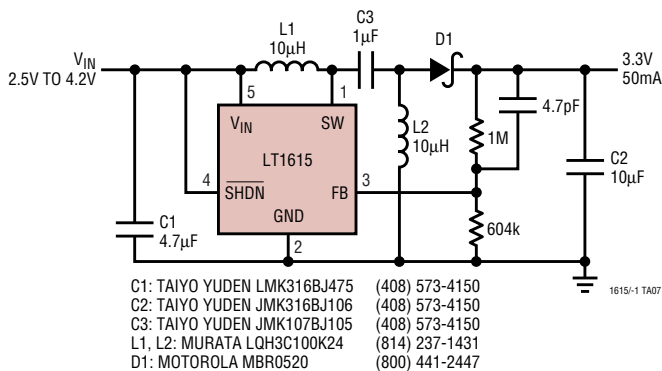

4-Cell to 5V SEPIC Converter

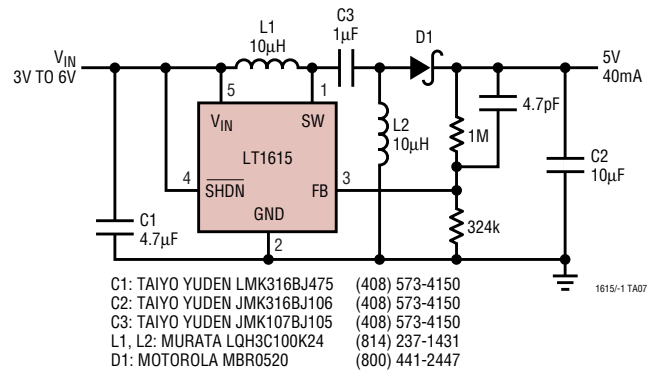

PIN Diode Driver

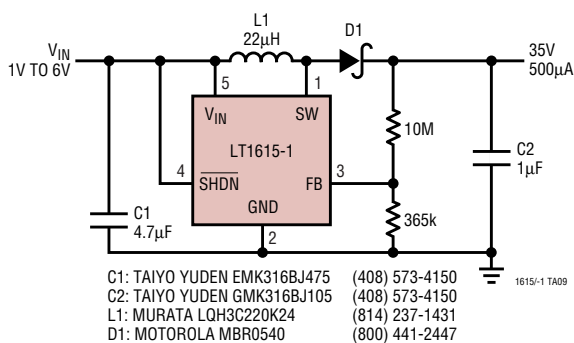

1-Cell to 3.3V Boost Converter

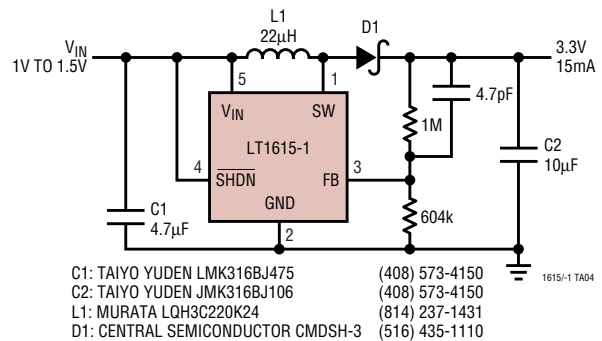

LT1615/LT1615-1

TYPICAL APPLICATIONS

±20V Dual Output Converter with Output Disconnect

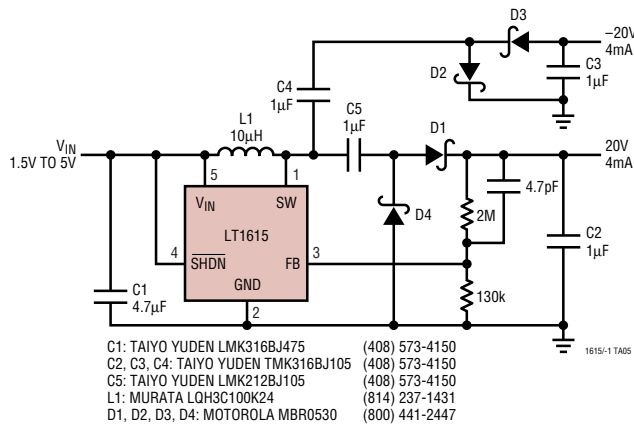

PACKAGE DESCRIPTION

S5 Package 5-Lead Plastic SOT-23

(Reference LTC DWG # 05-08-1633)

(Reference LTC DWG # 05-08-1635)

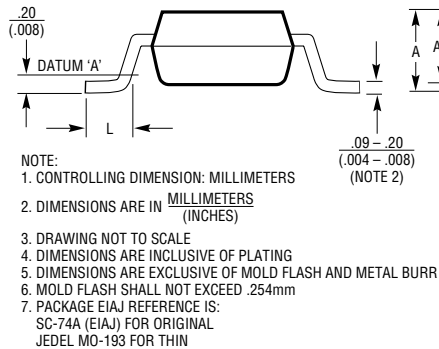

	SOT-23 (Original)	SOT-23 (ThinSOT)
A	.90 - 1.45 (.035 - .057)	1.00 MAX (.039 MAX)
A1	.00 - .15 (.00 - .006)	.01 - .10 (.0004 - .004)
A2	.90 - 1.30 (.035 - .051)	.80 - .90 (.031 - .035)
L	.35 - .55 (.014 - .021)	.30 - .50 REF (.012 - .019 REF)

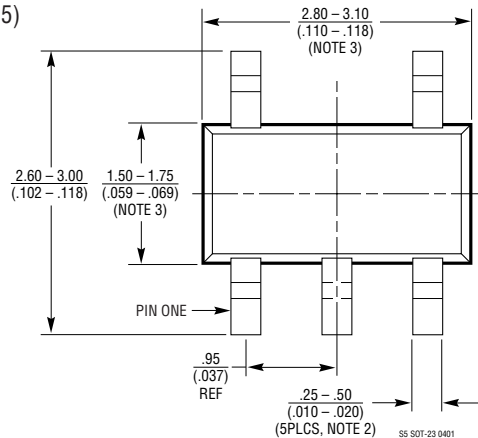

RELATED PARTS

PART NUMBER	DESCRIPTION	COMMENTS
LT1307	Single-Cell Micropower 600kHz PWM DC/DC Converter	3.3V at 75mA from One Cell, MSOP Package
LT1316	Burst Mode™ Operation DC/DC with Programmable Current Limit	1.5V Minimum, Precise Control of Peak Current Limit
LT1317	2-Cell Micropower DC/DC with Low-Battery Detector	3.3V at 200mA from Two Cells, 600kHz Fixed Frequency
LT1610	Single-Cell Micropower DC/DC Converter	3V at 30mA from 1V, 1.7MHz Fixed Frequency
LT1611	1.4MHz Inverting Switching Regulator in 5-Lead ThinSOT	-5V at 150mA from 5V Input, Tiny ThinSOT Package
LT1613	1.4MHz Switching Regulator in 5-Lead ThinSOT	5V at 200mA from 3.3V Input, Tiny ThinSOT Package
LT1617	Micropower Inverting DC/DC Converter in 5-Lead ThinSOT	-15V at 12mA from 2.5V Input, Tiny ThinSOT Package

Burst Mode is a trademark of Linear Technology Corporation

sn16151 16151fas



Linear Technology Corporation
 1630 McCarthy Blvd., Milpitas, CA 95035-7417
 (408)432-1900 • FAX: (408) 434-0507 • www.linear-tech.com

16151fa LT/TP 0601 1.5K REV A • PRINTED IN USA



© LINEAR TECHNOLOGY CORPORATION 1998